

ITEM #FA120

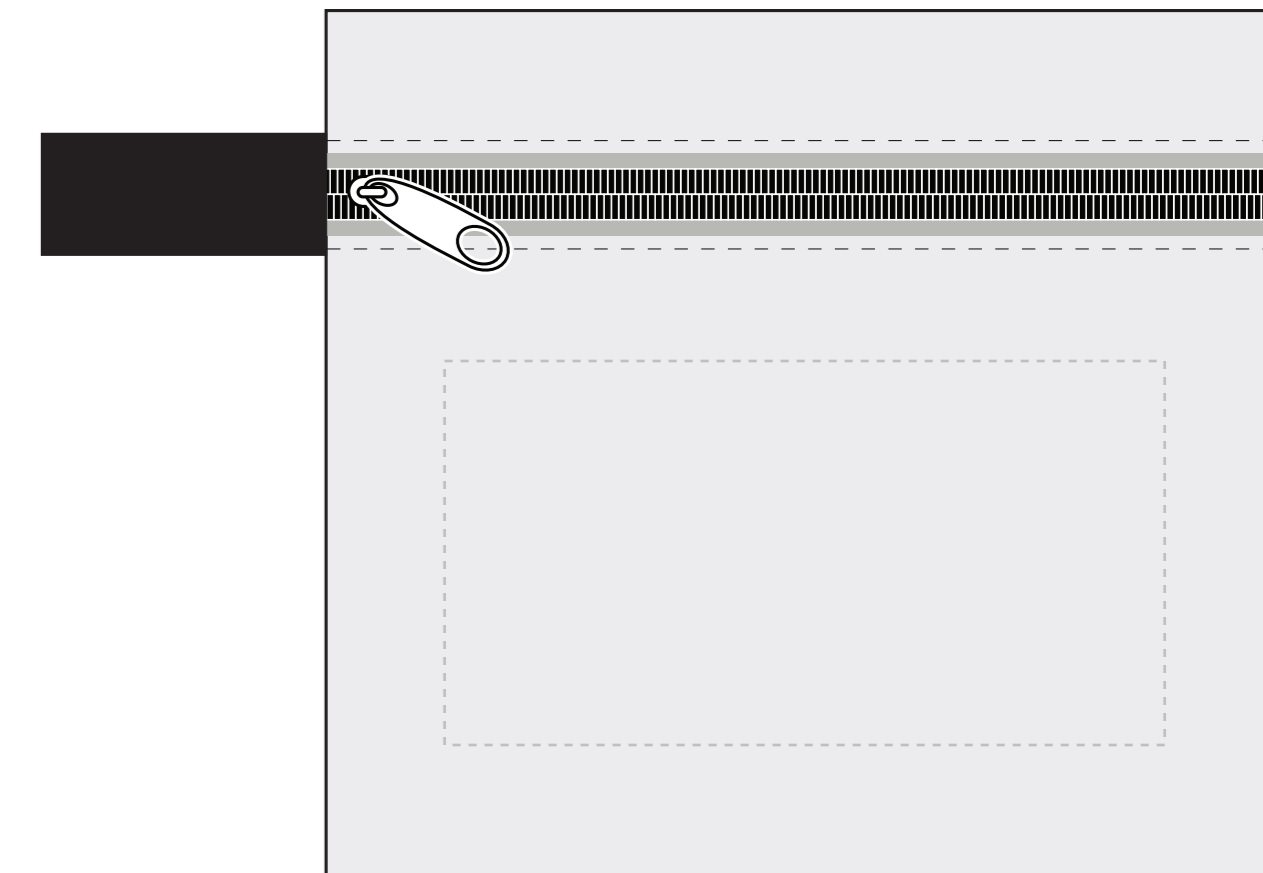
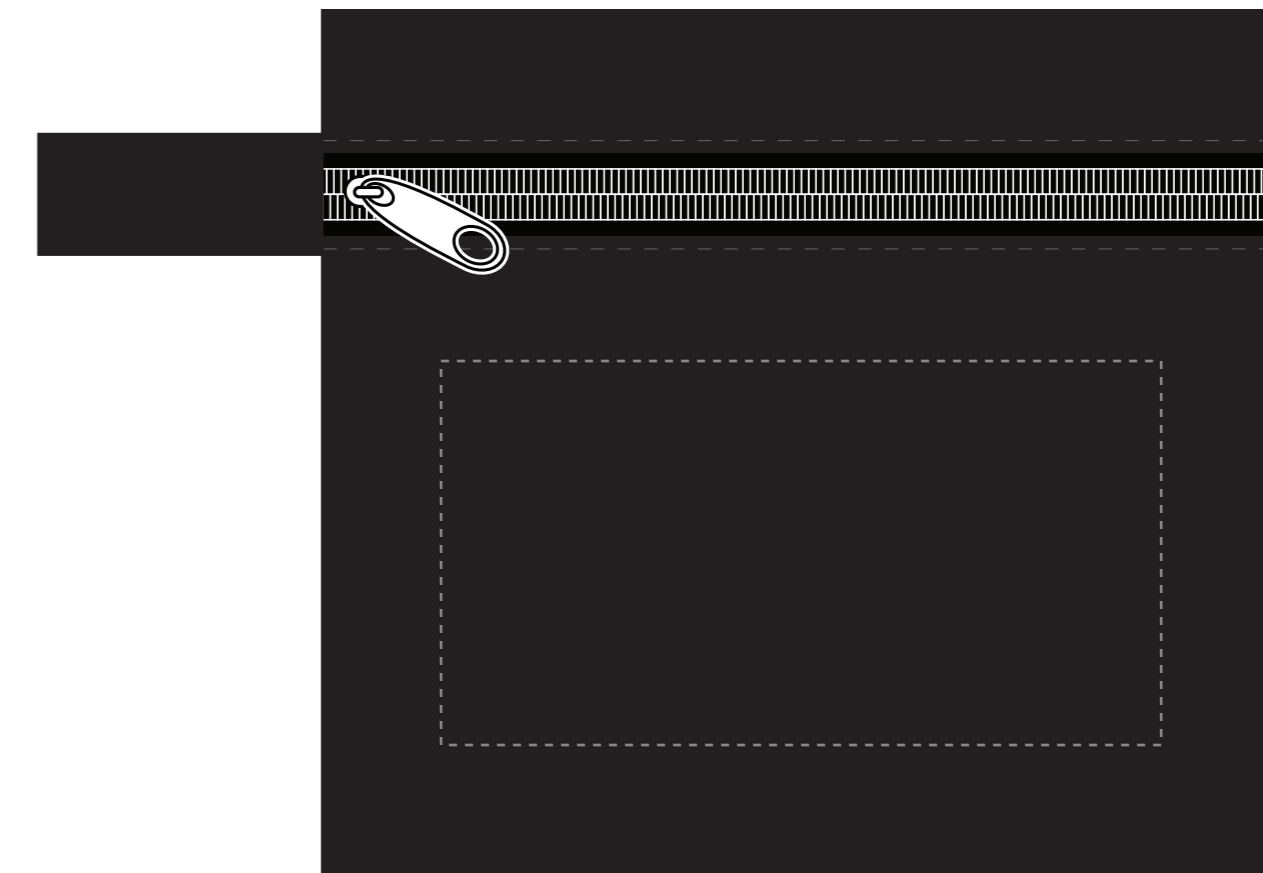
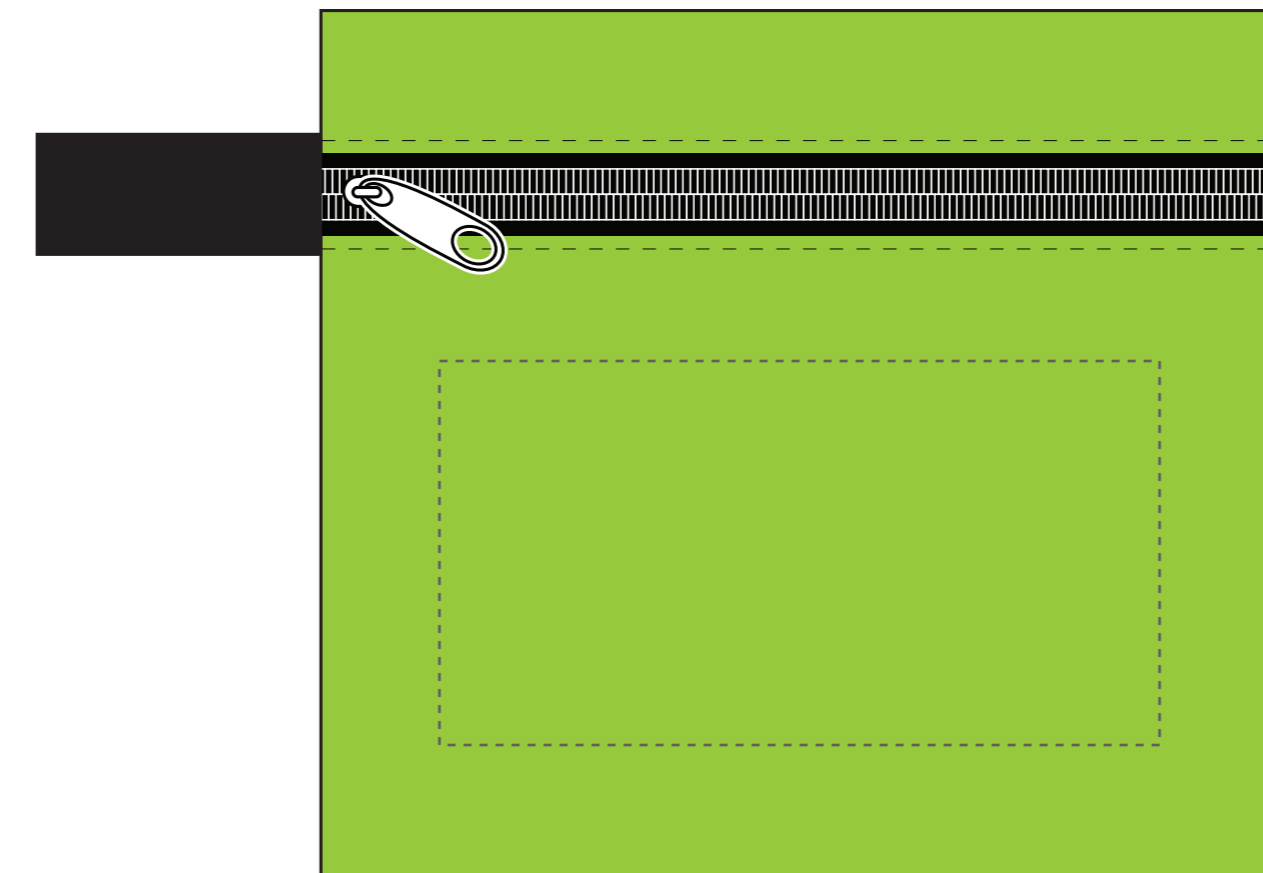
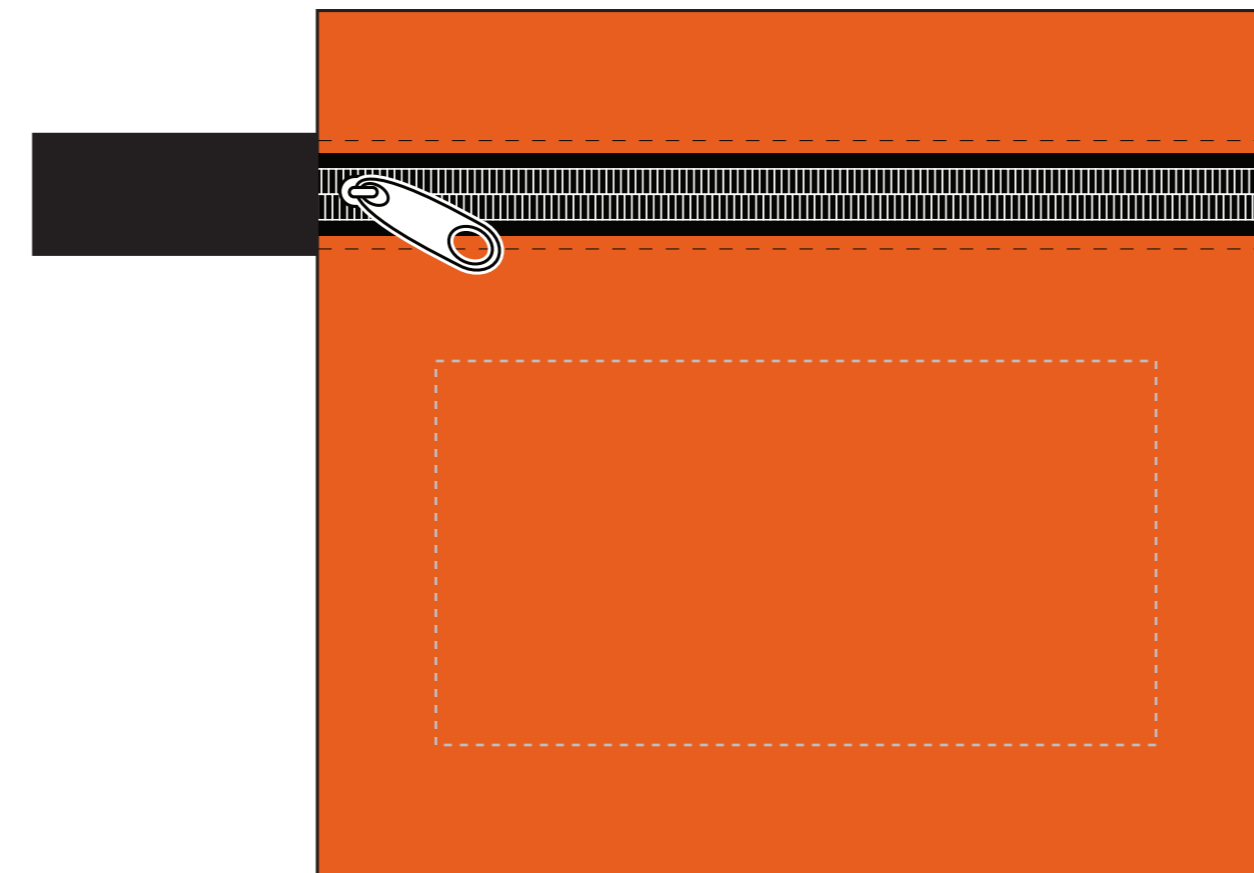
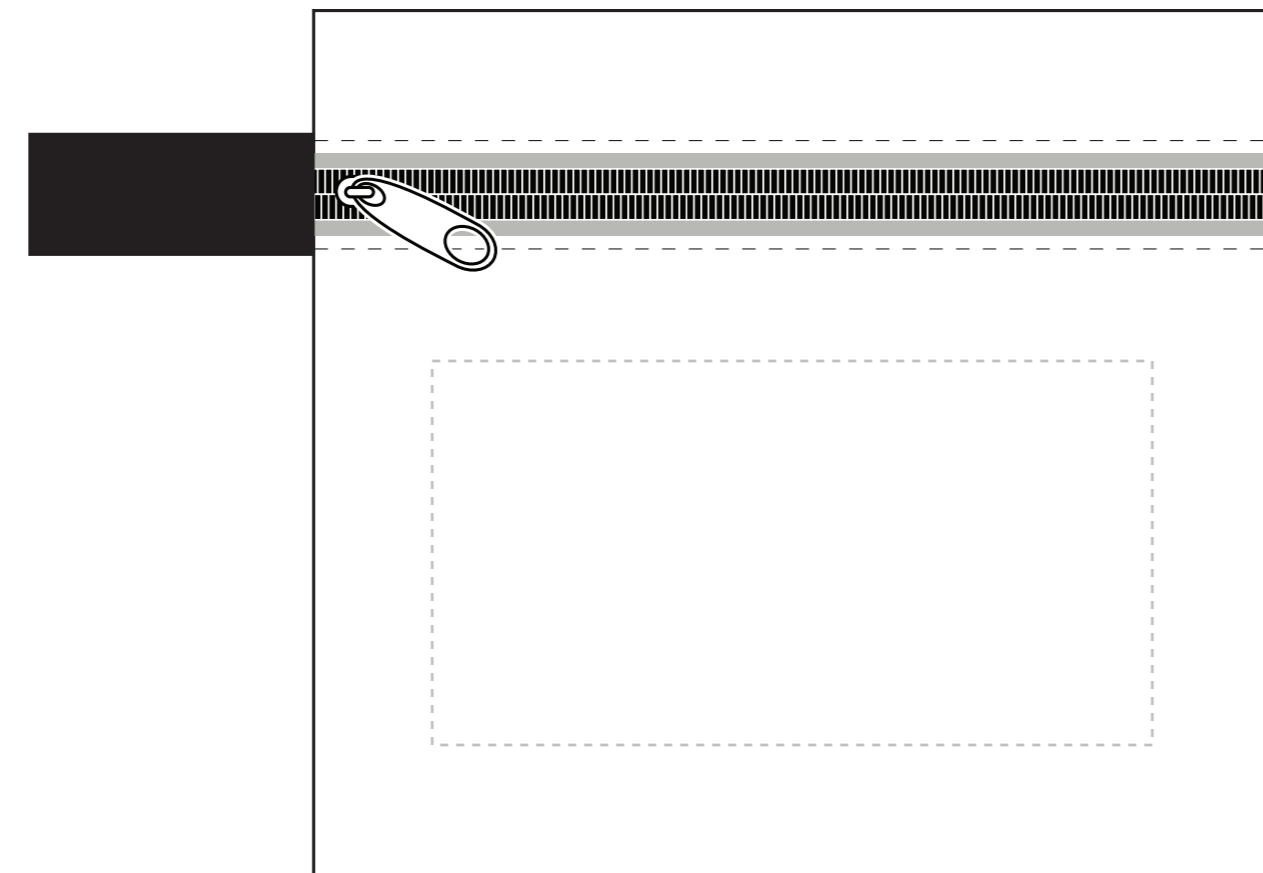
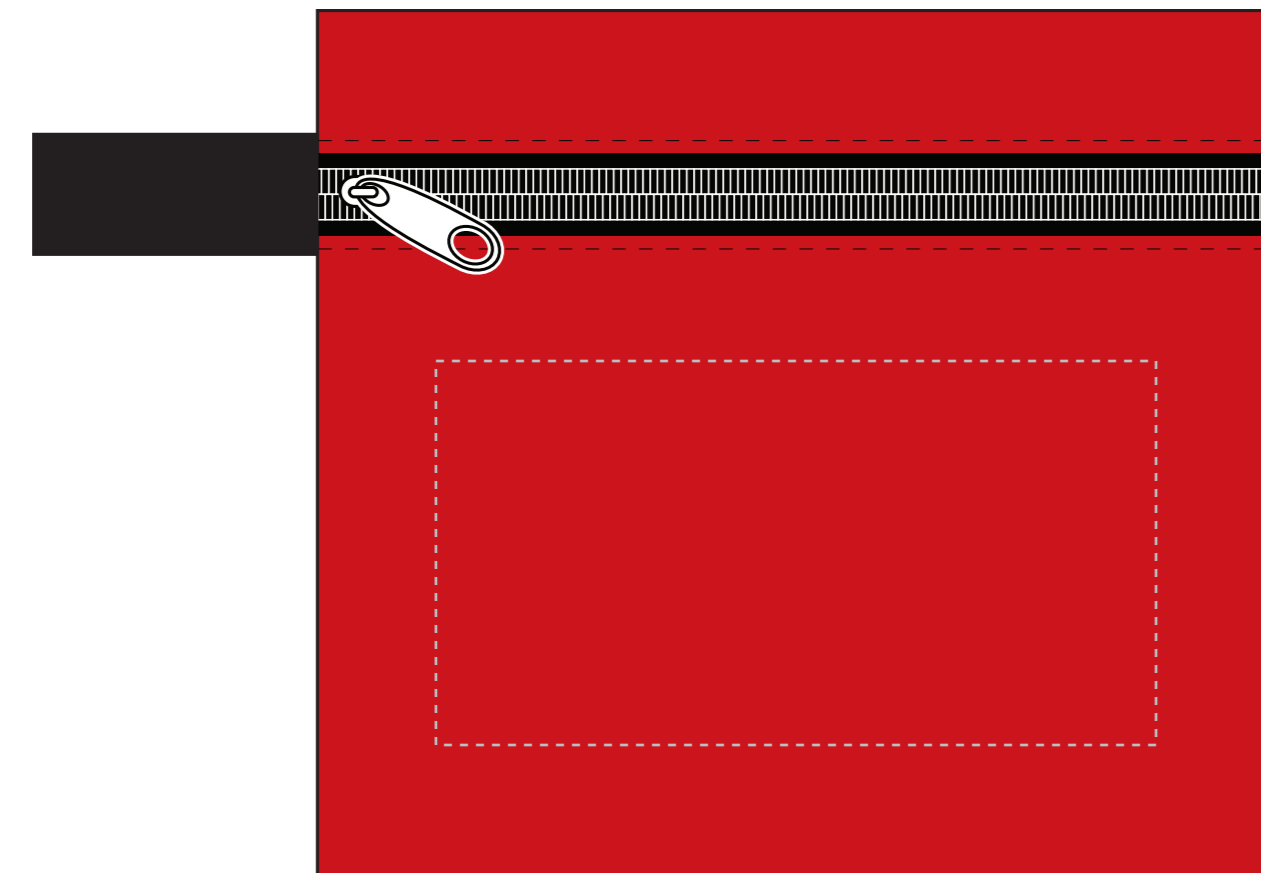
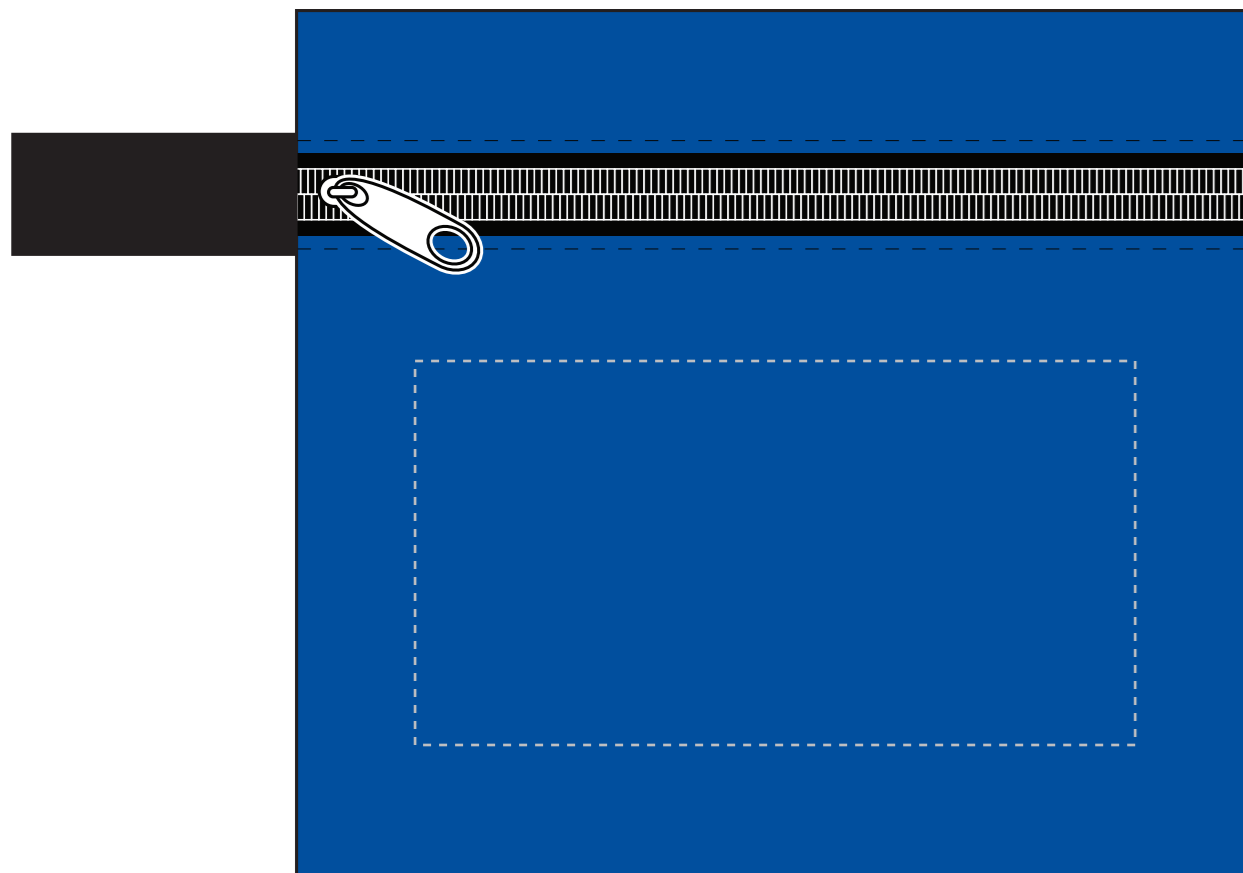

(Pouch # 5211)
Imprint area: 3.75"W x 2"H
100% of actual size

 = imprint area